

SRM2264L_{10/12}

HIGH SPEED CMOS 64K-BIT STATIC RAM

DESCRIPTION

The SRM2264L_{10/12} is an 8,192 words x 8 bits asynchronous, static, random access memory on a monolithic CMOS chip. Its very low standby power requirement makes it ideal for applications requiring non-volatile storage with back-up batteries. The asynchronous and static nature of the memory requires no external clock or refreshing circuit. Both the input and output ports are TTL compatible; and the three-state output allows easy expansion of memory capacity.

FEATURES

- Fast access time SRM2264L₁₀ 100ns (Max)
SRM2264L₁₂ 120ns (Max)
- Low supply current Standby : 0.5 μ A (Typ)
Operation: 47mA (Typ) 100ns
45mA (Typ) 120ns
- Completely static No clock required
- Single power supply 5V \pm 10%
- TTL compatible inputs and outputs
- 3-state output with wired-OR capability
- Non-volatile storage with back-up batteries
- Package SRM2264LC_{10/12} 28-pin DIP (plastic)
SRM2264LM_{10/12} 28-pin SOP (plastic)

BLOCK DIAGRAM

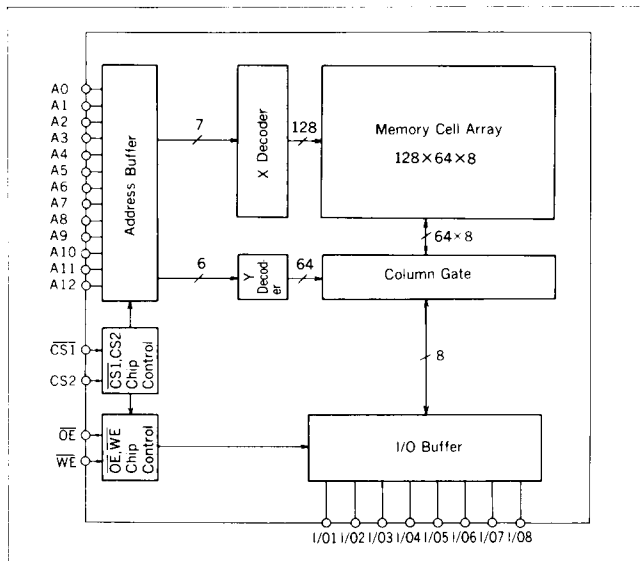

PIN CONFIGURATION

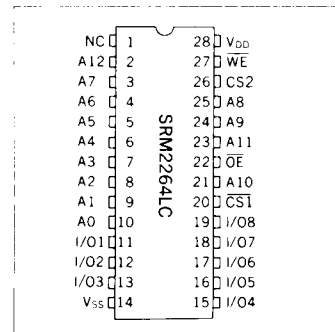

PIN DESCRIPTION

A0 to A12	Address Input
WE	Write Enable
OE	Output Enable
CS1, CS2	Chip Select
I/O1 to I/O8	Data I/O
VDD	Power Supply(+5V)
VSS	Power Supply(0V)
NC	No connection

ABSOLUTE MAXIMUM RATINGS(V_{SS}=0V)

Parameter	Symbol	Ratings	Unit
Supply voltage	V _{DD}	-0.5 to 7.0	V
Input voltage *	V _I	-0.5 to 7.0	V
Input/Output voltage*	V _{I/O}	-0.5 to V _{DD} +0.3	V
Power dissipation	P _D	1.0	W
Operating temperature	T _{opr}	0 to 70	°C
Storage temperature	T _{stg}	-65 to 150	°C
Soldering temperature and time	T _{sol}	260°C, 10s (at lead)	—

* V_I, V_{I/O} (Min) = -1.0V when pulse width is 50 ns(V_{SS} = 0V, T_a = 0 to 70°C)**RECOMMENDED DC OPERATING CONDITIONS**

Parameter	Symbol	Min	Typ	Max	Unit
Supply Voltage	V _{DD}	4.5	5.0	5.5	V
	V _{SS}	0	0	0	V
Input Voltage	V _{IH}	2.2	3.5	V _{DD} + 0.3	V
	V _{IL}	-0.3 *	—	0.8	V

ELECTRICAL CHARACTERISTICS

* If pulse width is less than 50 ns, it is -1.0V

DC Electrical Characteristics(V_{DD} = 5V ± 10%, V_{SS} = 0V, T_a = 0 to 70°C)

Parameter	Symbol	Conditions	SRM2264L10			SRM2264L12			Unit
			Min	Typ*	Max	Min	Typ*	Max	
Input leakage current	I _{LI}	V _I = 0 to V _{DD}	-1	—	1	-1	—	1	μA
Standby supply current	I _{DDS}	CS1=V _{IH} or CS2=V _{IL}	—	0.5	1.0	—	0.5	1.0	mA
	I _{DDS1}	CS1=CS2=V _{DD} -0.2V or CS2≤0.2V	—	0.5	20	—	0.5	20	μA
Average operating current	I _{DDA}	V _I =V _{IL} , V _{IH} I _{I/O} =0mA t _{avg} =Min	—	47	82	—	45	80	mA
Operating supply current	I _{DDO}	V _I =V _{IL} , V _{IH} I _{I/O} =0mA	—	35	60	—	35	60	mA
Output leakage	I _{LO}	CS1=V _{IH} or CS2=V _{IL} or \overline{WE} =V _{IL} or \overline{OE} =V _{IH} , V _{I/O} =0 to V _{DD}	-1	—	1	-1	—	1	μA
High level output voltage	V _{OH}	I _{OH} =-1.0mA	2.4	V _{DD} -0.1	—	2.4	V _{DD} -0.1	—	V
Low level output voltage	V _{OL}	I _{OL} =4.0mA	—	0.2	0.4	—	0.2	0.4	V

Terminal Capacitance(f = 1MHz, T_a = 25°C)

Parameter	Symbol	Conditions	Min	Typ	Max	Unit
Address Capacitance	C _{ADD}	V _{ADD} = 0V	—	3	5	pF
Input Capacitance	C _I	V _I = 0V	—	5	6	pF
I/O Capacitance	C _{I/O}	V _{I/O} = 0V	—	6	7	pF

AC Electrical Characteristics O Read Cycle(V_{DD} = 5V ± 10%, V_{SS} = 0V, T_a = 0 to 70°C)

Parameter	Symbol	Conditions	SRM2264L10		SRM2264L12		Unit
			Min	Max	Min	Max	
Read cycle time	t _{RC}	*1	100	—	120	—	ns
Address access time	t _{ACC}		—	100	—	120	ns
CS1 access time	t _{ACS1}		—	100	—	120	ns
CS2 access time	t _{ACS2}		—	100	—	120	ns
OE access time	t _{OE}		—	50	—	60	ns
CS1 output set time	t _{CLZ1}	*2	10	—	10	—	ns
CS1 output floating time	t _{CHZ1}		—	35	—	40	ns
CS2 output set time	t _{CLZ2}		10	—	10	—	ns
CS2 output floating time	t _{CHZ2}		—	35	—	40	ns
OE output set time	t _{OLZ}		5	—	5	—	ns
OE output floating time	t _{OHZ}	—	35	—	40	ns	
Output hold time	t _{OH}	*1	10	—	10	—	ns

O Write Cycle

Parameter	Symbol	Conditions	SRM2264L10		SRM2264L12		Unit
			Min	Max	Min	Max	
Write cycle time	t _{WC}	*1	100	—	120	—	ns
Chip select time 1	t _{CW1}		80	—	85	—	ns
Chip select time 2	t _{CW2}		80	—	85	—	ns
Address enable time	t _{AW}		80	—	85	—	ns
Address setup time	t _{AS}		0	—	0	—	ns
Write pulse width	t _{WP}		60	—	70	—	ns
Address hold time	t _{WR}		0	—	0	—	ns
Input data setup time	t _{DW}		50	—	50	—	ns
Input data hold time	t _{DH}		0	—	0	—	ns
WE output floating	t _{WHZ}	*3	—	35	—	40	ns
WE output setup time	t _{OW}		5	—	5	—	ns

*** 1 Test Conditions**

1. Input pulse level : 0.8V to 2.4V
2. tr = tf = 10ns
3. Input and output timing reference levels : 1.5V
4. Output load I_{rrL} + C_L = 100pF

*** 3 Test Conditions**

1. Input pulse level : 0.8V to 2.4V
2. tr = tf = 10ns
3. Test circuit

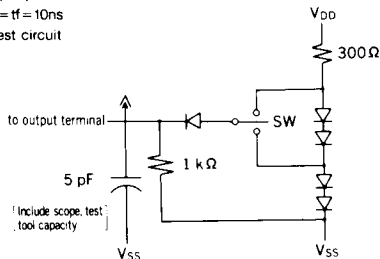

Test : t_{ow}, t_{whz} Hi-Z → "H" and "H" → Hi-Z SW is V_{DD} side
 Test : t_{ow}, t_{whz} Hi-Z → "L" and "L" → Hi-Z SW is V_{SS} side

Output turnon turnoff time

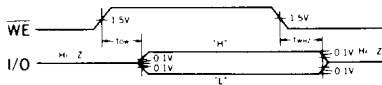

*** 2 Test Conditions**

1. Input pulse level : 0.8V to 2.4V
2. tr = tf = 10ns
3. Test circuit

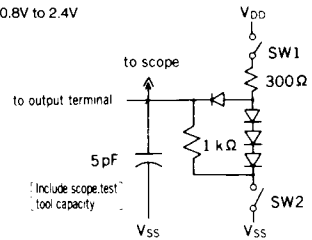

Test : t_{ch1}, t_{ch2}, t_{ohz} Both SW1 and SW2 are close
 Test : t_{clz1}, t_{clz2}, t_{olz} Hi-Z → "H" SW1 is open, SW2 is close.
 Test : t_{clz1}, t_{clz2}, t_{olz} Hi-Z → "L" SW1 is close, SW2 is open.

Output turnon turnoff time

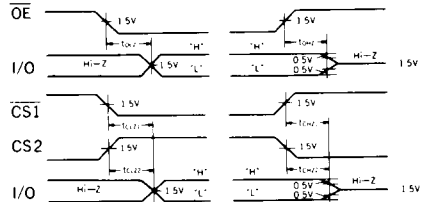

● Timing Chart

○ Read Cycle

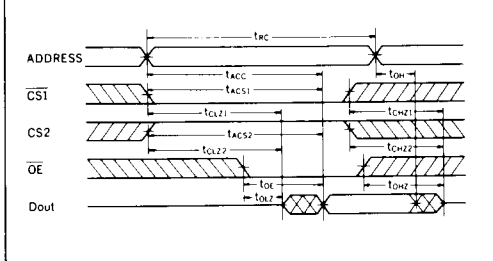

○ Write Cycle (1) (CS1 Control)

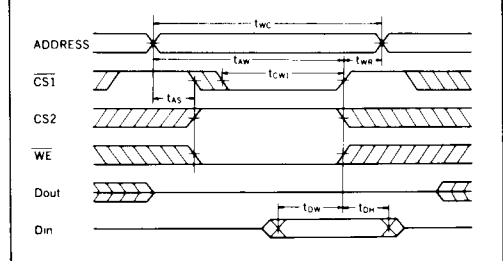

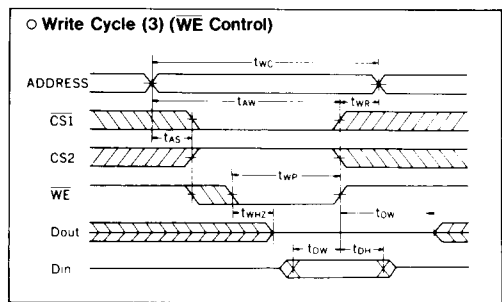
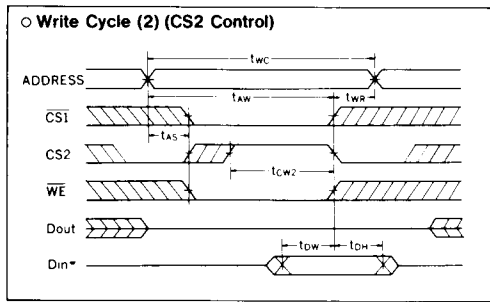

- Note : 1. During read cycle time, \overline{WE} is to be "H" level.
 2. During write cycle time that is controlled by CS1 or CS2, Output Buffer is in high impedance state whether \overline{OE} level is "H" or "L".
 3. During write cycle time that is controlled by \overline{WE} , Output Buffer is high impedance state if \overline{OE} is "H" level.

■ DATA RETENTION CHARACTERISTIC WITH LOW VOLTAGE POWER SUPPLY

($T_a = 0$ to 70°C)

Parameter	Symbol	Conditions	Min	Typ	Max	Unit
Data retention supply voltage	V_{DDR}		2.0	—	5.5	V
Data retention current	I_{DDR}	$V_{\text{DD}} = 3\text{V}$ $\text{CS1} = \text{CS2} = V_{\text{DD}} - 0.2\text{V}$ or $\text{CS2} = 0.2\text{V}$	—	—	10	μA
Chip select data hold time	t_{CDR}		0	—	—	ns
Operation recovery time	t_{R}		t_{RC}^*	—	—	ns

* t_{RC} = Read cycle time

Data retention timing ($\overline{CS1}$ Control)

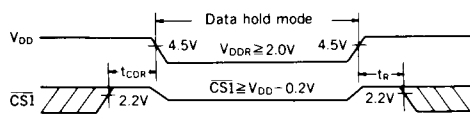

Data retention timing (CS2 Control)

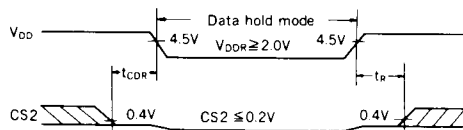

■ FUNCTIONS

● Truth Table

CS1	CS2	OE	WE	A0 to A12	DATA I/O	Mode	I_{DD}
H	X	—	—	—	Hi-Z	Unselected	$I_{\text{DDS}}, I_{\text{DDS1}}$
—	L	—	—	—	Hi-Z	Unselected	$I_{\text{DDS}}, I_{\text{DDS1}}$
L	H	X	L	Stable	Input data	Write	I_{DDO}
L	H	L	H	Stable	Output data	Read	I_{DDO}
L	H	H	H	Stable	Hi-Z	Output disable	I_{DDO}

X: "H" or "L", —: "H", "L" or "Hi-Z"

● Reading data

Data is able to be read when the address is setted while holding $\overline{CS1} = "L"$, $\text{CS2} = "H"$, $\overline{OE} = "L"$ and $\overline{WE} = "H"$. Since Data I/O terminals are in high impedance state when $\overline{OE} = "H"$, the data bus line can be used for any other objective, then access time apparently is able to be cut down.

● Writing data

There are the following four ways of writing data into the memory.

- (1) Hold $\overline{CS2}$ = "H", \overline{WE} = "L" set addresses and give "L" pulse to $\overline{CS1}$.
- (2) Hold $\overline{CS1}$ = "L". \overline{WE} = "L", set addresses and give "H" pulse to $\overline{CS2}$.
- (3) Hold $\overline{CS1}$ = "L", $\overline{CS2}$ = "H", set addresses and give "L" pulse to \overline{WE} .
- (4) After setting addresses, give "L" pulse to $\overline{CS1}$, \overline{WE} and give "H" pulse to $\overline{CS2}$.

Anyway, data on the Data I/O terminals are latched up into the SRM2264L_{90/10/12} at the end of the period that $\overline{CS1}$, \overline{WE} are "L" level, and $\overline{CS2}$ is "H" level. As Data I/O terminals are in high impedance state when any of $\overline{CS1}$, \overline{OE} = "H", or $\overline{CS2}$ = "L", the contention on the data bus can be avoided.

● Standby mode

When $\overline{CS1}$ is "H" or $\overline{CS2}$ is "L" level, the SRM2264L_{90/10/12} is in the standby mode which has retaining date operation. In this case Data I/O terminals are Hi-Z, and all inputs of addresses, \overline{WE} and data can be any "H" or "L". When $\overline{CS1}$ and $\overline{CS2}$ level are in the range over V_{DD} -0.2V, or $\overline{CS2}$ level is in the range under 0.2V, in the SRM2264L_{10/12} there is almost no current flow except through the high resistance parts of the memory.

■ PACKAGE DIMENSIONS

C28

28-pin DIP

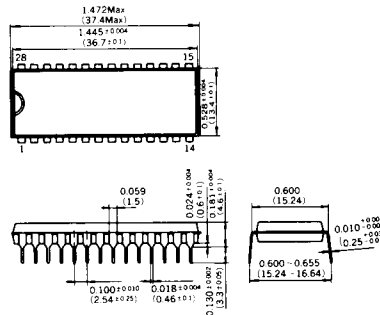
unit : inch
(mm)

M28-2 *1

28-pin SOP

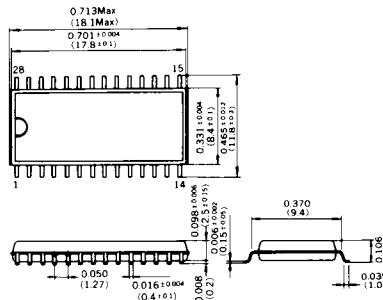
unit : inch
(mm)

*1 SRM2264LM_{90/10/12} has the same characteristics as SRM2264LC_{90/10/12}.

■ CHARACTERISTICS CURVES

